

Toolkits for innovation: how digital technologies empower users in new product development

Thomas Schäper^{1,*} , J. Nils Foege²  and Stephan Nüesch^{1,3} 

¹Institute for Entrepreneurship, University of Muenster, Geiststraße 24-26, Muenster, 48145, Germany.

²Innovation Management Group, Leibniz University Hannover, Königsworther Platz 1, Hannover, D-30167, Germany. nils.foege@wa.uni-hannover.de

³International Institute of Management in Technology, University of Fribourg, Bd de Pérolles 90, Fribourg, 1700, Switzerland. stephan.nueesch@unifr.ch

In recent decades, toolkits for innovation have been increasingly used to integrate users into new product development processes. They promise to empower users in these processes by providing design freedom and iterative learning for the transformation of ideas into products. Despite these potential benefits, little is known about how these often digital toolkits compare to traditional design methods, and what role previous experience of users in new product development plays. To compare the effectiveness of toolkits for innovation with physical product modeling, we conducted a two-stage laboratory experiment in the form of an innovation challenge. One hundred non-expert and 46 expert users created new product designs, which were subsequently evaluated by an independent jury. Our results show that users with no experience in digital or physical design tasks develop more innovative product ideas when using a digital toolkit for innovation than when they use physical product modeling, while expert users seem to be able to use both methods with equal success. We, thereby, show that toolkits for innovation are a powerful way to translate users' solution information into a prototype. Moreover, our results indicate that the usage of a digital toolkit for innovation decreases the quality gap between the designs of non-expert and expert users in new product development.

1. Introduction

In recent decades, the use of digital technologies for integrating users into new product development processes has become a driver for the transformation of traditional innovation activities in many industries (von Hippel, 2001; Urbinati et al., 2020; Ciarli

et al., 2021). Digitally enabled technologies such as additive manufacturing and computer-aided design (CAD) enable users to quickly turn abstract ideas into tangible prototypes (Rindfleisch et al., 2017; Beltagui et al., 2020; Marion and Fixson, 2021), thereby expanding the scope of possible product offerings and blurring the divide between physical and

digital spaces (Lipson and Kurman, 2013; Becker et al., 2021; Claussen and Halbinger, 2021). As these technologies empower user innovation, they shift innovation processes from a manufacturer-active to a customer-active paradigm (Wang, 2021).

Traditionally, firms have dedicated substantial resources to eliciting need information from the users of their products to eliminate imperfections in current products or come up with new product ideas (von Hippel, 2005; Gemser and Perks, 2015; Becker et al., 2021). While researchers suggest that most users can articulate their needs regarding new or existing products (Piller and Walcher, 2006; Ihl et al., 2018; Zhu et al., 2019), they likewise stress that users' ability to provide firms with solution information is limited. This limitation is rooted in users' lack of knowledge of modeling techniques, design principles, and tools (Droge et al., 2009; Magnusson, 2009; Marion and Fixson, 2021). Toolkits for innovation are a promising solution to this issue. They are a digital technology, which enables users to translate solution ideas to problems into real prototypes that can be tested and observed (Franke and Piller, 2004; Elia et al., 2020; Pesch et al., 2021).

Despite the immense potential of user toolkits for innovation to transfer solution knowledge between users and firms, we know surprisingly little about how users interact with these toolkits and whether they empower users to create product innovations (Alcácer et al., 2016; Foucart and Li, 2021; Boudreau et al., 2022). For instance, Opland et al. (2022, p. 262) call for further research "into how digital tools affect the [...] digital innovation process" and how they provide value in the innovation process. While many innovation toolkits exist, they often cater to a narrow range of users or assume a certain level of knowledge and resources that may not be available to all innovators (Opland et al., 2022). In this context, Appio et al. (2021) call for additional research to explore what capabilities or skills are necessary for utilizing digital tools.

While expert users, who are trained in highly complex digital product design software and/or non-digital design tools, should be able to translate their solutions into prototypes, non-expert users simply lack the skill to do so (Poetz and Schreier, 2012), leaving their creative potential untapped. Therefore, toolkits for innovation are especially valuable for non-expert users who seek to transfer a solution idea to one of their problems into a prototype, as well as for firms that are interested in drawing on such solutions for their innovation processes. Prior researchers were unable to investigate toolkits for innovation because they could not build toolkits that fulfilled the five criteria for them set by von Hippel in his seminal (2001)

paper. Picking up this notion, Opland (2022, p. 262) calls for research "into the design of more sophisticated digital tools for innovation purposes, using new and advanced technology." Considering this call, we set out to answer the following research questions: *How can firms build a toolkit for innovation that possesses the five attributes defined by von Hippel (2001)? How does such a toolkit for innovation compare to physical product modeling? And what role does the level of users' expertise in new product development play for both approaches?*

To answer these questions, we conducted a two-stage laboratory experiment. In the first stage, we created an innovation challenge with 146 participants: 100 non-expert users and 46 professional product designers. While the non-expert users in our experiment were completely new to product design, all the expert users had extensive training and practice in conducting physical design relying on paper, pencil, tools, and modeling compounds, as well as CAD. We instructed both user groups to create an innovative drinking vessel and randomly assigned them to either use physical modeling techniques or a toolkit for innovation. In the second stage, each member of an independent jury of three non-expert and three expert users, who did not participate in the design challenge, evaluated the products' innovativeness.

The results of our analyses support our theorizing that product ideas composed with a digital toolkit for innovation are more innovative than those product ideas created by physical design approaches and that expert users' ideas are more innovative than those of non-expert users. Beyond that, we find that designs of non-expert users created with a toolkit for innovation received higher scores than those built physically. This was not the case for expert users, indicating that it is non-expert users who profit from toolkits for innovation when translating their solutions into prototypes.

Our study contributes to the literature on user innovation and toolkits for innovation in three important ways. First, we respond to inquiries from prior research (e.g., Appio et al., 2021; Di Vaio et al., 2021; Marion and Fixson, 2021) by demonstrating that innovation toolkits can effectively facilitate new product development by transforming users' solution information into prototypes. Notably, our research finds that non-expert users benefit from using toolkits for innovation, as they tend to create more innovative products than when using physical product modeling. Secondly, our study proposes and confirms that innovation toolkits can help to reduce the discrepancy in product design quality between non-expert and expert users. By utilizing digital toolkits, firms can access a wider range of users as

potential sources for new product ideas, rather than relying solely on expert users. Finally, we introduce and evaluate a digital innovation toolkit that satisfies the five criteria established by von Hippel (2001). Although our toolkit is an example of how such toolkits can be developed inexpensively, it is also a serious attempt to expand research on innovation toolkits beyond the study of tools for mass customization (Goduscheit and Jørgensen, 2013).

2. User toolkits for innovation

2.1. The concept of user toolkits for innovation

The integration of users into new product development processes has revolutionized innovation activities in various industries (Chesbrough et al., 2018; Urbinati et al., 2020; Becker et al., 2021). Toolkits for innovation simplify the producer–customer interaction and shift the innovation process from a producer-active paradigm to a customer-active paradigm, thereby facilitating fast access to information and smooth transfer of ideas (Jong and Bruijn, 2013; Balka et al., 2014; Urbinati et al., 2020). These toolkits allow firms to integrate users into new product development processes and transfer knowledge and solutions to current problems (von Hippel, 2017; Bstieler et al., 2018; Usai et al., 2021). They increase users' engagement in creating new solutions through non-mediated interactions with the manufacturing firm (Nambisan, 2002; Piller and Walcher, 2006; Ciarli et al., 2021). The use of toolkits for innovation is conducive to innovation challenges as they enable a broad range of users to participate in innovation activities that lead to a multitude of idiosyncratic product designs (Piller and Walcher, 2006; Marion and Fixson, 2021; Pesch et al., 2021). Von Hippel (2005, p. 147) notes that “the goal of a toolkit is to enable non-specialist users to design high-quality, producible custom products that exactly meet their needs.” Users apply a toolkit to create a preliminary design, prototype it, evaluate its functioning in their personal use cases, and then iteratively refine it until it fits their needs (von Hippel, 2005).

2.2. The five attributes of toolkits for innovation

According to von Hippel (2001), proper toolkits for innovation have five essential attributes: they (1) enable learning by doing through trial and error, (2) provide an appropriate solution space, (3) are user-friendly, (4) come with preinstalled module libraries,

and (5) facilitate the transformation of user designs into real products.

2.2.1. Learning by doing through trial and error

Toolkits for innovation enable users to go through complete cycles of trial-and-error learning when creating product designs (von Hippel, 2001). The transfer of information between the user and the manufacturer makes it possible to verify and evaluate the outcomes of initial design choices and improve them (Jeppesen, 2002).

2.2.2. Appropriate solution space

According to von Hippel (2001), toolkits for innovation offer a broad set of possible solutions with a high degree of design freedom. The solution space – the range of possible solutions – is not tied to a particular production system.

2.2.3. User-friendliness

Toolkits for innovation must be user-friendly, for instance by having simple, well-structured user interfaces and clear arrangements of functions. It should be possible for users with little or no training in design and new product development to operate them (von Hippel and Katz, 2002).

2.2.4. Module libraries

Toolkits for innovation provide their users with vast arrays of modules to support them – ready-made elements that together can make up new designs. For instance, architects can use and combine standard materials and structural components when designing custom office buildings. This streamlines the typical innovation process of creating new products by arranging previously designed components in new ways (Henkel and Thies, 2003).

2.2.5. Translating user designs for production

Finally, toolkits for innovation combine seamlessly with the manufacturer's production system as they provide a standard language for users and manufacturers without incurring additional expenses for transferring the information to the production system (von Hippel, 2001). Custom products can be produced without modifying the manufacturer's equipment.

2.3. Application and effectiveness of toolkits for innovation

Additive manufacturing and digital tools such as CAD have increased the importance of toolkits for innovation, enabling the development and production of physical products by consumers (Nambisan, 2017; Claussen and Halbinger, 2021; Marion and Fixson, 2021). User-friendly digital modeling tools

such as Tinkercad have made 3D design accessible without extensive training (Rindfleisch et al., 2017; Urbinati et al., 2020). The decreasing cost of additive manufacturing and increasing availability of materials are democratizing the technology (Rindfleisch et al., 2017; Becker et al., 2021). However, evidence about the influence of toolkits for innovation on new product development is limited, and some studies only partially correspond to von Hippel's criteria for true toolkits for innovation (Jeppesen, 2002; Kamali and Loker, 2002; Dellaert and Stremersch, 2003; Franke and von Hippel, 2003; Goduscheit and Jørgensen, 2013). Confusion arises as toolkits for mass customization are often marketed as tools for innovation, but they differ in important ways.

3. Hypotheses

3.1. Toolkits for innovation and physical product modeling

Toolkits for innovation offer various opportunities for users to ideate and create personal value (Jeppesen and Molin, 2003; Beltagui et al., 2020; Ciarli et al., 2021). They provide users with guidance and assistance during the design process, leading to more innovative designs. Unlike physical product modeling, which may require more time, resources, and experience, toolkits simplify ideation and creation, including visual demonstrations and module libraries that inspire novel design possibilities (Baldwin and von Hippel, 2011; Urbinati et al., 2020). This guidance can help users create customized products that fit their needs, leading to more innovative designs (Franke and Schreier, 2002; Elia et al., 2020). Moreover, toolkits are typically more accessible and require less specialized knowledge or equipment than physical product modeling approaches. They offer a more scalable and accessible approach to design and open up the design process to a wider range of individuals, potentially leading to more diverse and innovative designs (von Hippel, 2001).

Toolkits for innovation offer greater flexibility in the design process and reduce the effort required to develop new products, allowing designers to iterate quickly and easily (Rindfleisch et al., 2017; Claussen and Halbinger, 2021; Marion and Fixson, 2021). Unlike physical product modeling, which may require the creation of multiple physical prototypes, toolkits allow designers to make changes in a digital environment. Users can experiment with different ideas and approaches, which may result in more innovative designs. Moreover, by automating many of the testing and production processes, toolkits reduce the

amount of time and effort required to develop new products. This can free up users to focus on other aspects of the design process, such as ideation and prototyping, leading to more innovative designs overall (Schreier, 2006).

Finally, toolkits for innovation enable users to engage intensely in a digital design process, experience quick progress, and ultimately achieve mastery, all of which contribute to increased feelings of self-efficacy and pride (Kruglanski, 1975; Avey et al., 2009). This can lead to a greater investment of time and effort in the design process, resulting in higher-quality, more innovative designs (Sieger et al., 2013; Dawkins et al., 2017). We therefore hypothesize:

Hypothesis 1 Product ideas designed through a toolkit for innovation are more innovative than those developed through physical product modeling.

3.2. Experience in product development

Innovation challenges often bring together groups of users with different levels of expertise to solve specific design tasks within a given timeframe (Ihl et al., 2018; Zhu et al., 2019; Claussen and Halbinger, 2021). Non-expert users are useful in identifying unmet needs and expressing their preferences for product features or implementation processes (von Hippel, 2001). However, they lack the technical knowledge and experience in product modeling, design, or prototyping required to transfer their solution information into a prototype (Magnusson, 2009; Ciarli et al., 2021).

Expert users, on the other hand, possess the technical knowledge to convert ideas into product solutions (e.g., Poetz and Schreier, 2012; Crawford and Di Benedetto, 2015; Elia et al., 2020). They possess the required solution information and ample knowledge of general design principles, modeling techniques, and digital tools (Droge et al., 2009; Ciarli et al., 2021). They can quickly iterate on designs and test different options, resulting in more refined product solutions (Ulrich and Eppinger, 2012; Elia et al., 2020). As they tend to invest a lot of time into designing new products or enhancing existing ones, expert users have a higher level of abstraction, which helps them to better transform ideas into real products (von Hippel, 2001; Becker et al., 2021).

Amabile (1996) argues that technical, procedural, and intellectual knowledge are the main drivers for generating innovative ideas. A broad set of skills, information, and knowledge increases the likelihood of producing something new (Kristensson et al., 2004; Urbinati et al., 2020). The design

capabilities of expert users allow them to perform design tasks effectively and create solutions of high quality (Poetz and Schreier, 2012; Marion and Fixson, 2021).

Moreover, experienced designers can envision the full potential of a product, considering a range of possibilities that may not be obvious to non-expert users (Weisberg, 1993; Magee, 2005). They also have a deeper understanding of user needs, based on years of experience designing for different audiences and markets. Experienced designers are also more likely to be exposed to the latest industry trends, technologies, and innovations. This knowledge can be leveraged to create truly innovative products and ahead of their time (Kristensson et al., 2004; Beltagui et al., 2020). This can lead to more innovative and useful product designs (Ulrich and Eppinger, 2012; Usai et al., 2021). We therefore hypothesize:

Hypothesis 2 Product ideas designed by expert users are more innovative than those designed by non-expert users.

3.3. Toolkits for innovation and experience in product development

Toolkits for innovation are effective in enabling non-expert users to create and customize products that meet their specific needs (Becker et al., 2021). By providing users with trial-and-error cycles and high design freedom through an appropriate solution space, toolkits allow them to identify their real needs and develop highly innovative and fully customized products (von Hippel and Katz, 2002; Claussen and Halbinger, 2021; Usai et al., 2021). Additionally, the user-friendly interface and module libraries stimulate creativity and convey an understanding of feasible solutions (Piller et al., 2004; Marion and Fixson, 2021).

One major advantage of toolkits for innovation is that they set the level of knowledge necessary for developing new products to a minimum (Poetz and Schreier, 2012; Ciarli et al., 2021). This is particularly beneficial for non-expert users who lack design training and experience (Elia et al., 2020; Usai et al., 2021). To create an individualized product, non-expert users need only the ability to operate the toolkit, as the complex testing and manufacturing are completely handled by the toolkit and the manufacturer (Franke and Schreier, 2002; Claussen and Halbinger, 2021). This fact mitigates some of the major downsides of physical approaches to collecting user ideas and innovations, as it renders skill and experience in sketching, product modeling, and

production unnecessary and provides non-expert users with guidance and assistance during the design process. However, for experienced designers, the benefits of using a toolkit may not outweigh the perceived effort of using it (von Hippel, 2001; Urbinati et al., 2020).

Expert users who are accustomed to physical product modeling may find it challenging to switch to using digital tools, as digital tools lack the tactile feedback that physical product modeling offers (Hendler, 2019). Tactile feedback helps designers understand the physical properties of materials and how they interact with each other. Without this feedback, designers may struggle to create innovative designs that consider the physical properties of materials.

Moreover, expert users may require specialized software tools that can handle complex simulations or modifications, or that can integrate with other software tools (Beltagui et al., 2020). These tools may be more expensive or require additional training to use, which can be a barrier to adoption for some users. Expert users may also have established workflows and processes that have been refined over years of experience (Kristensson et al., 2004). They may be resistant to changing their processes or learning new software, which can make it difficult to adopt new digital tools.

Taken together, we hypothesize:

Hypothesis 3 The lack of experience in product modeling positively moderates the relationship between using toolkits for innovation to design products and their innovativeness.

4. Methodology

4.1. CAD and additive manufacturing as a user toolkit for innovation

To create a toolkit for innovation, we combined two different free-of-charge software solutions, Tinkercad and Shapeways. First, Tinkercad and Shapeways provide full cycles of *trial-and-error learning*. Users can design a product in Tinkercad as the user domain and then verify its feasibility with Shapeways as the manufacturer domain. For this purpose, Shapeways automatically scans the product design and provides feedback about any potential production errors such as too-thin walls or loose parts. Second, Tinkercad has a wide *solution space* for modeling product ideas. Users can resize the workspace, manipulate heights, widths, and lengths, and use different camera angles. Third, both software solutions are *user-friendly*. Tinkercad is a

simplified and well-documented software for beginner to expert users, while Shapeways provides a good visualization of the production feasibility based on drag-and-drop principles. Fourth, Tinkercad possesses a wide variety of structural *modules*, ranging from simple to complex. These modules can be modified in shape or size and freely combined with other modules. Fifth, the toolkit for innovation provides *translation for production* with the transfer of the model from the user to the manufacturer domain, as users can directly order the product they designed if there are no production issues.

An overview of how a combination of the two software solutions complies with the five attributes is shown in Figure 1.

4.2. Experimental design

To test our conceptual considerations, we conducted an experiment in the form of an innovation challenge (Piller and Walcher, 2006). The innovation challenge was designed as a two-stage process: the development of new product designs and a jury evaluation of the innovativeness of the designs.

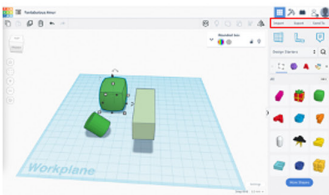
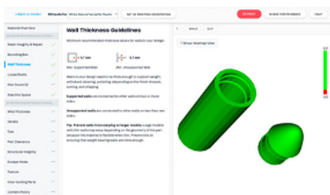
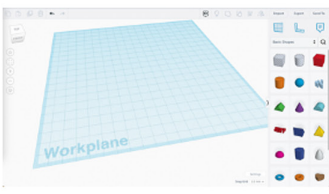
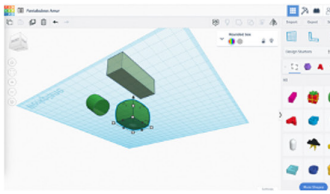
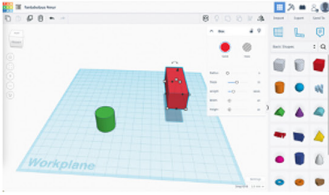

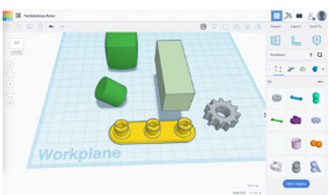
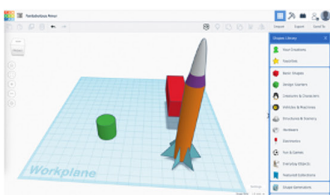
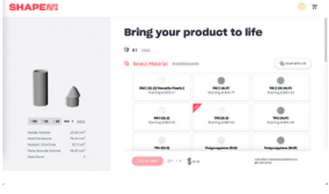
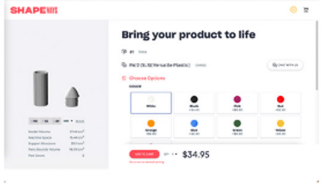
Five Attributes by von Hippel (2001)	Tinkercad and shapeways
<p>1. Trial-and-error learning</p>	<p>Users can design product ideas in Tinkercad, and Shapeways verifies their feasibility and suggests improvements if needed.</p>  
<p>2. Appropriate solution space</p>	<p>Users can resize the workspace, manipulate heights, widths, and lengths, and use different camera angles.</p>  
<p>3. User-friendliness</p>	<p>Both software systems feature drag-and-drop and easy visualization.</p>  
<p>4. Module libraries</p>	<p>Tinkercad possesses a wide variety of structural modules, ranging from simple to complex. These modules can be modified in shape or size and freely combined with other modules.</p>  
<p>5. Translation for production</p>	<p>Models can be transferred from Tinkercad to Shapeways for production.</p>  

Figure 1. Combining Tinkercad and Shapeways to comply with the five attributes of toolkits for innovation. [Colour figure can be viewed at [wileyonlinelibrary.com](https://onlinelibrary.wiley.com)]

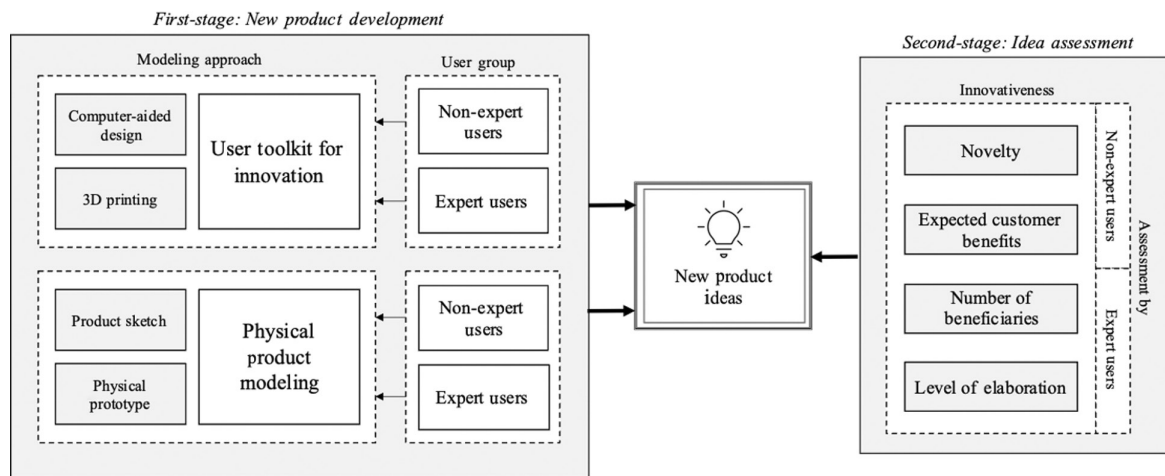


Figure 2. Experimental design.

Figure 2 provides an overview of our experimental design.

4.3. First stage: new product development

4.3.1. Modeling approach

Within the first stage of the experiment, we compared the output of two modeling approaches: toolkits for innovation and physical product modeling. While the toolkits for innovation approach comprises a digital product modeling with the toolkit described above, i.e., a combination of Tinkercad and Shapeways, the physical product modeling approach consists of product modeling with physical tools, such as pen, paper, and Styrofoam.

4.3.2. User groups

We recruited two different user groups as participants in our experiment. We went to various courses in architecture, design, and business administration for two weeks and distributed flyers to promote our innovation challenge. Our non-expert users were students without any knowledge of product design, product modeling (whether digital or physical), CAD software, or additive manufacturing. By contrast, our expert users were advanced design or architecture students who possessed extensive knowledge in these domains, as all of them had already conducted prior product design projects using digital tools and physical product modeling (on average 8.70 physical and 12.38 digital design models). We recruited 100 non-expert and 46 expert users to participate in our experiment.

4.3.3. Task and execution

We instructed all 146 subjects – 100 non-expert and 46 expert users – to develop a drinking vessel. There

were no restrictions in terms of functions, materials, or usage. Additionally, the participants had to describe their idea in written form, including information on the product's name, materials, shape, and functions. We chose a low-tech task and a topic from everyday life, drinking vessels, to ensure that every participant was familiar with it. Furthermore, this task leaves a lot of room for new ideas and allows for changes to existing products. The participants had two hours to develop their product idea in both approaches. Each subject received a participation fee of €28. We provided a further incentive, rewarding the most innovative, second most innovative, and third most innovative idea with a €150, a €100, and a €50 Amazon voucher.

We randomly distributed the participants of each user group equally across both modeling approaches, resulting in a 4×4 matrix (Figure 3). Non-expert and expert users within the toolkits for innovation approach used Tinkercad, a simplified CAD program, to model their product idea. To become acquainted with the software, subjects started with a short hands-on software tutorial. After completing the tutorial, they developed their product idea with the toolkit. To ensure producibility, Shapeways automatically analyzed whether the model could be processed with additive manufacturing. Any necessary corrections were disclosed to the participant. We instructed the other users to create their products with physical product modeling and provided them with all the required materials (pencils, paper sheets, knives, rulers, and Styrofoam). They were instructed to sketch their product and subsequently build a prototype out of Styrofoam. Figure 4 presents images of the experimental setting and the execution of the experiment.

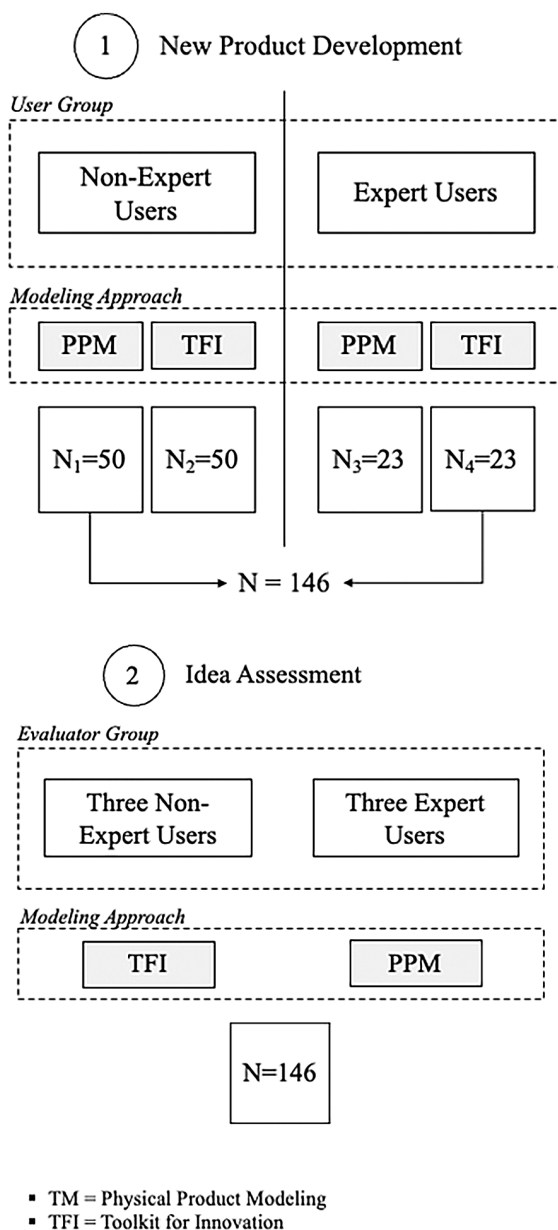


Figure 3. Stages of the innovation challenge.

4.4. Second stage: idea assessment

4.4.1. Product catalog

In preparation for the idea assessment, we collected all product ideas and descriptions and created a product catalog for each modeling approach consisting of a product description (including name, materials, shape, and functions), a sketch, and product pictures. To ensure comparability between both approaches, we took pictures of the physical product ideas and included screenshots of the toolkit for innovation approach (see Figure A1).

4.4.2. Process of idea assessment

An independent jury was instructed to evaluate the product ideas' innovativeness (see Figure 3). Following Toubia and Florès (2007), the jury consisted of three newly non-expert and expert users. The jury received a unique and randomized collection of all idea submissions.

To assess the innovativeness of the new product idea, we use the Consensual Assessment Technique developed by Amabile (1982, 1996). This is a well-established method for measuring the novelty and originality of newly designed products when functional measures, such as sales, R&D efficiency, and patent citations, are not available (Conti et al., 1995). The jury had to assess the novelty, usefulness, number of beneficiaries, and level of elaboration on a 7-point Likert scale (1 – fully disagree to 7 – fully agree). New products or services are classified as innovative to the extent that individuals independently agree (Amabile, 1996).

The judges discretely assessed all criteria – novelty, expected customer benefits, number of beneficiaries, and level of elaboration – without getting any further explanations or having any discussions with other evaluators. This impeded biases from group dynamics, social acceptability, and hierarchical status. All evaluations took place at the same time in different rooms. After all the evaluators completed their assessments, we calculated the consensus. High levels of consensus would imply that the evaluations were reliable, valid, and of high quality. Intraclass correlation coefficients, which are based on Pearson's correlation coefficient, determine the degree of consensus (Shrout and Fleiss, 1979; McGraw and Wong, 1996). Values above 0.7 represent high degrees of consensus. If this threshold is fulfilled and reliability is assured, all ratings of one idea are combined and weighted equally to one overall value. All four intraclass correlation coefficients rank above the threshold of 0.7, indicating high degrees of consensus.

4.5. Measures

We used *innovativeness* as our dependent variable. It consists of four elements: novelty, expected customer benefits, number of beneficiaries, and level of elaboration. Each element is measured on a seven-point Likert scale ranging from 1 (strongly disagree) to 7 (strongly agree). To calculate the innovativeness score for each product idea, all scores of the items are weighted equally and divided by the number of evaluators to refer to our Likert scale measurement from 1 to 7.

The *modeling approach* serves as the independent variable and is dichotomous (1=Toolkit



Figure 4. Pictures of the innovation challenge – toolkit for innovation and physical product modeling. [Colour figure can be viewed at [wileyonlinelibrary.com](https://onlinelibrary.wiley.com)]

for Innovation Approach, 0=Physical Product Modeling). Our second independent variable *experience in new product development* is dichotomous (1=Experience in new product development, 0=No experience in new product development). To measure the combined effect of both independent variables, we created an interaction term.

We also incorporated different control variables to account for possible confounding factors on innovativeness. First, we used the measure of *personal innovativeness* from Agarwal and Prasad (1998), which assesses the willingness of individuals to try out new information technologies. Second, we used a measure of *innovativeness in product purchases* following Ailawadi et al. (2001), which determines the degree to which a consumer engages in exploratory behaviors, when it comes to trying out new and different things. Third, we also included the *perceived product innovativeness*, which was assessed by the participants for their developed product idea

and is measured by the Consensual Assessment Technique criteria. Fourth, following van Dyne and Pierce (2004), we accounted for a user's *psychological ownership* toward the product idea. Finally, we introduced the *age* of the participants in our analysis.

4.6. Analysis

In line with prior research, we use linear regression to analyze our cross-sectional data. Moreover, we conduct a subgroup analysis for each modeling approach and user group. A Breusch-Pagan test reveals the existence of heteroscedasticity. Hence, robust standard errors are included in the regression. Variance inflation factors are calculated to detect multicollinearity issues in the dataset. Since all variance inflation factors are below 5, which is considered the cut-off value for collinearity problems, there are no issues concerning multicollinearity. Moreover, a Durbin-Watson test confirms the absence of autocorrelation.

5. Results

5.1. Descriptive results

One-hundred forty-six people participated in our innovation challenge: 100 non-expert and 46 expert users. Our non-expert users were students without any knowledge of product design, product modeling (whether digital or physical), CAD software, or additive manufacturing. The expert users in our sample had considerable experience in product design, as they had created in their career an average of 8.70 physical product models and 12.38 CAD models and invested 41 hours of work in their last physical product model and 31 hours of work in their last CAD model. All non-expert users in our sample had no previous experience in physical product modeling or toolkit modeling, as they had never designed a product before participating in our experiment. A total of 57.2% of the participants were male and 42.8% were female. The average age of our participants was 22.29, and 32.19% held a university degree.

Figure 5 provides an overview of the distribution of the innovativeness for the evaluated product ideas for each modeling approach. The most innovative idea was “StableCup,” a cup for people with Parkinson’s disease with an integrated stabilizer to enable drinking without spilling. The second most innovative idea of our innovation challenge went to “Drink Fun,” a drinking toy for children that helps adults to administer medicine to their children in a playful way. The third most innovative idea is “Drinking Reminder,” which notifies elderly people if their hydration level is too low and sends an alarm to any nursing staff who may be taking care of

them. Pictures of the most innovative ideas from the toolkit for innovation and physical product modeling approach are shown in Figure A1.

Figure 6 provides an overview of the distribution of the innovativeness for each user group and modeling approach. The graphs show that non-expert users received higher innovativeness scores with the toolkit than with physical product modeling. The mean of the innovativeness for non-expert users in the physical product modeling approach was 3.93 and 4.21 in the toolkit approach. By contrast, expert users scored slightly lower with the toolkit (mean=4.22) than with the physical modeling approach (mean=4.55). *T*-tests revealed that the differences for non-expert users are statistically significant ($p=0.073$) but not for expert users ($p=0.926$).

5.2. Results from regression analysis

In Hypothesis 1, we suggested that the toolkit for innovation approach would lead to more innovative product ideas than the physical modeling approach. The results of our regression (Model 1 and 3 – Table 1) show a positive and statistically significant relationship between the toolkit approach and innovativeness ($\beta=0.44$; $p=0.015$). These findings provide statistical evidence for Hypothesis 1.

In Hypothesis 2, we expected that expert users with prior experience in product modeling would outperform non-expert users across both modeling approaches in our innovation challenge. Our findings (Model 2 and 3 – Table 1) suggest a positive and statistically significant relationship between prior experience in product modeling and innovativeness ($\beta=0.56$; $p=0.034$). Therefore, we can confirm Hypothesis 2.

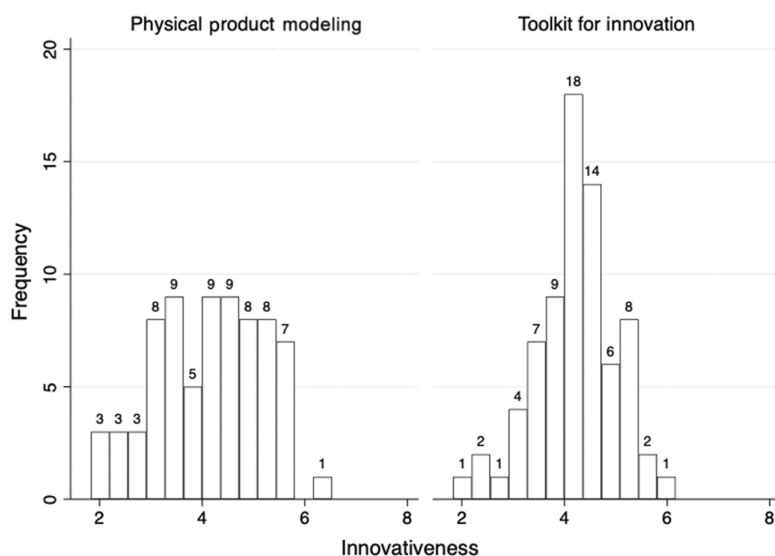


Figure 5. Number of ideas per innovativeness interval.

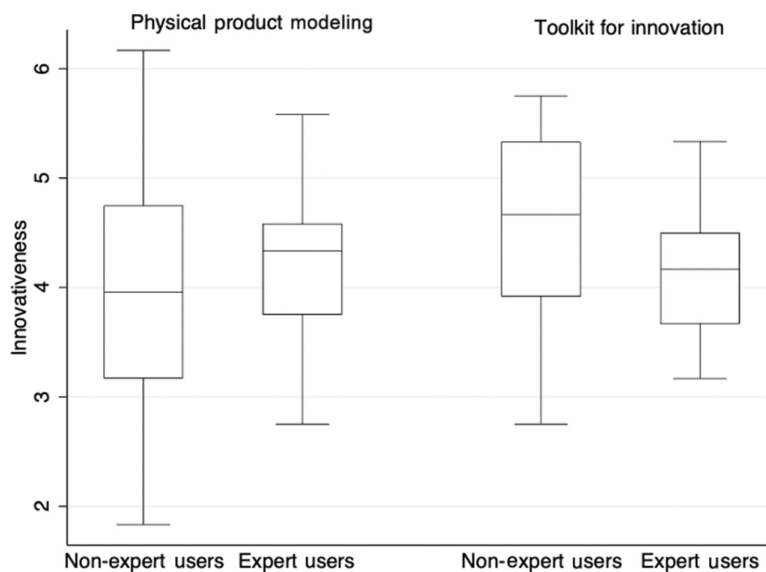


Figure 6. Innovativeness scores for each modeling approach and user group.

Table 1. Regression results for Hypotheses 1–3

	Model 1	Model 2	Model 3
Dependent variable	Innovativeness	Innovativeness	Innovativeness
Controls			
Personal innovativeness in information technology	0.10 (0.07)	0.09 (0.07)	0.11 (0.07)
Innovativeness product purchase	-0.02 (0.09)	-0.02 (0.09)	-0.07 (0.09)
Perceived product innovativeness	0.24** (0.07)	0.20** (0.07)	0.22** (0.07)
Psychological ownership	-0.07 (0.07)	-0.06 (0.07)	-0.06 (0.07)
Age	0.03 (0.03)	0.04 (0.03)	0.03 (0.03)
Explanatory			
Toolkit for innovation approach	0.27* (0.15)		0.44** (0.18)
Experience in new product development		0.30* (0.17)	0.56** (0.26)
Interaction			
Toolkit for innovation × experience in new product development			-0.54* (0.30)
Intercept	2.25*** (0.86)	2.27*** (0.87)	2.17*** (0.88)
F-value	3.02	3.09	3.36
p-value	0.00	0.00	0.00
R ²	0.13	0.13	0.17
N	146	146	146

Standard errors are robust. Statistical significance is reported as *** $p < 0.01$; ** $p < 0.05$; * $p < 0.1$.

In Hypothesis 3, we proposed that the lack of experience in product modeling positively moderates the relationship between using toolkits for innovation to design products and their innovativeness. The results of our moderation (Model 3 – Table 1) indicate that the interaction of prior experience and the toolkit modeling approach is negative and significant ($\beta = -0.54$; $p = 0.068$). A visualization in Figure 7 shows that the slope of the non-expert user group is positive and steeper than the negative slope of expert users when moving from the physical product modeling to the toolkit for innovation approach. A simple

slope difference test reveals a positive and significant gradient of slope for the non-expert user group ($\alpha = 0.56$; $p = 0.034$). However, there is no significant slope gradient for the expert user group ($\alpha = 0.02$; $p = 0.923$).

To analyze this relationship in greater detail, we conducted a sample split for non-expert and expert users. The results in Table 2 show a positive and significant relationship between using a toolkit for innovation and non-expert users ($\beta = 0.460$; $p = 0.011$). Moreover, we find that there is no significant relationship between using a toolkit for innovation and

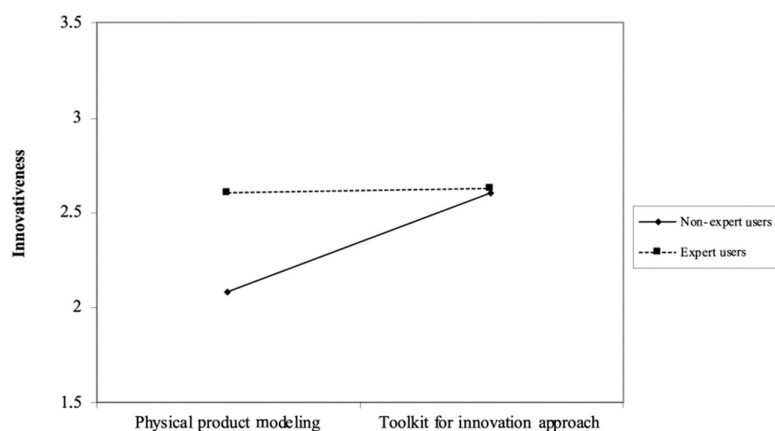


Figure 7. Interaction plot for user groups and modeling approaches.

Table 2. Subsample analysis for toolkits for innovation versus physical product modeling for non-expert and expert users

Dependent variable	Non-expert users	Expert users
	Innovativeness	Innovativeness
Controls		
Personal innovativeness in information technology	0.10 (0.09)	0.12 (0.10)
Innovativeness product purchase	-0.06 (0.11)	0.03 (0.16)
Perceived product innovativeness	0.30** (0.09)	0.04 (0.12)
Psychological ownership	-0.12 (0.10)	0.02 (0.11)
Age	0.04 (0.04)	0.02 (0.08)
Explanatory		
Toolkit for innovation approach	0.46** (0.18)	-0.27 (0.26)
Intercept		
	1.88* (0.97)	3.11* (1.79)
F-value	3.88	0.99
p-value	0.00	0.45
R ²	0.19	0.1
N	100	46

Standard errors are robust. Statistical significance is reported as *** $p < 0.01$; ** $p < 0.05$; * $p < 0.1$.

expert users ($\beta = -0.274$; $p = 0.294$). Therefore, we have to partially reject Hypothesis 3.

6. Discussion

6.1. Discussion of results

Our study found that the toolkit for innovation approach leads to more innovative product ideas than physical product modeling, which is consistent with previous research (von Hippel, 2005; Magnusson, 2009). Toolkits for innovation offer advantages such as limitless possibilities, module libraries, and translation for production, making them a better option for integrating non-expert users in the new product development process.

Expert users design more innovative product ideas than non-expert users, but relying solely on internal design professionals may limit a company's capacity to find innovative solutions (Helfat, 1994; Elia et al., 2020). Our study shows that expert users with experience in designing new products and manufacturing them, and knowledge of efficient processes for ideation, idea screening, and rapid prototyping are more likely to generate innovative product ideas (von Hippel, 2005; Marion and Fixson, 2021).

Non-expert users develop more innovative product ideas with toolkits for innovation than with physical modeling approaches but may experience higher levels of stress (Teresko, 1994; Huffman and Kahn, 1998; Friesen, 2001). Sixty-four percent of the non-expert users who employed a toolkit for innovation in our innovation challenge said afterward that it would have been easier for them to use a physical product modeling approach.

Our findings suggest that the toolkit approach empowers users without experience in product design or technical knowledge to create products that fit their needs but may overwhelm users with too many design choices and lead to confusion.

6.2. Contribution to research

Our findings contribute to the literature on user innovation and toolkits for innovation in three ways. First, we demonstrate that digital innovation toolkits can enhance new product development by efficiently converting users' solution information into a prototype, even though individual experience serves as an important boundary condition for their effectiveness (Rindfleisch et al., 2017; Opland et al., 2022). Non-expert users without experience in new product development were able to increase the quality of their product ideas through the application of a toolkit

over physical modeling. The toolkit approach provides users with a systematic problem-solving process, ideation, and prototyping, leading to innovative products and services. Additionally, we show that innovation toolkits are dispensable for expert users as they create equally innovative product ideas with or without the toolkit.

Second, we find that toolkits for innovation can help to close the gap in the innovativeness of product designs between non-expert and expert users in new product development (Huesig and Endres, 2019; Appio et al., 2021). With the growing interest in new technologies such as additive manufacturing and CAD, adopting digital applications gains importance for companies to tap into the needs and desires of users rather than relying solely on market research (Rindfleisch et al., 2017; Claussen and Halbinger, 2021). Toolkits allow firms to access a broader range of users as sources for new product ideas, reducing reliance on lead users and other experts. Using a larger pool of users gives firms access to product development for the commercial market, as non-expert users possess the necessary information for creating fitting products.

Third, we create an innovation toolkit that fully meets von Hippel's (2001) five criteria by combining CAD and additive manufacturing software to provide a clear connection between the user and the manufacturer domain. While previous toolkits – such as customized watches (Franke and Piller, 2004), skis (Franke et al., 2008), and security software (Franke and von Hippel, 2003) – do not fully qualify as toolkits for innovation as they fail to meet von Hippel's five criteria of trial-and-error cycles, appropriate solution space, user-friendliness, module libraries, and translation of user design into production. Our approach shows that it is not only possible to create an innovation toolkit but also practical and very inexpensive (Appio et al., 2021).

6.3. Implications for practice

Our study yields several important insights for managers and policymakers who seek to implement customers and toolkits for innovation in their new product development processes.

Managers can provide innovation toolkits to users and encourage collaboration between users with different levels of experience in product modeling to enhance innovation (Bresciani et al., 2021). Toolkits are especially useful for involving a large number of people in the development of new products, as they help to translate intangible ideas into products. Typically, these developments are limited to lead users; however, with the application of

a toolkit, managers can open development to the general public and tap into much greater innovation potential (Rindfleisch et al., 2017). We suggest that product managers leverage the increasing acceptance of digital technologies to boost their product development but also pay attention to the prior knowledge of the particular user. Most users without experience in product design are not aware of the availability of software that lets them create products. Most tools are already well-developed and applicable to real use cases. Firms can benefit from using free software solutions for problems within the company or generating new product ideas without investing a lot of money or time. The adoption of these technologies can enable firms to digitally integrate users in a scalable approach (Rindfleisch et al., 2017). They can also offer training and support to help users employ innovation toolkits effectively and promote a culture of innovation within their organizations by recognizing and rewarding innovative ideas, encouraging experimentation, and providing a supportive environment that fosters creativity and innovation (Huesig and Endres, 2019; Di Vaio et al., 2021).

Policymakers can incorporate the use of innovation toolkits in education and training programs to equip individuals with the skills and knowledge required to develop innovative products (Appio et al., 2021). They can also provide support and resources to organizations that use innovation toolkits, such as funding for research and development and access to technology and other resources that facilitate innovation. Another implication for policymakers is the establishment of innovation labs that integrate toolkits for innovation or other digital tools. They can provide support and resources to establish the lab, such as funding, space, and access to technology and other resources. These labs provide a platform for cross-sectoral collaboration, experimentation, and prototyping, which can lead to the development of innovative products, services, and business models.

6.4. Limitations and future research

Our study has some limitations that provide fertile ground for future research. First, we used an experimental setting to analyze the effectiveness of toolkits for innovation in new product development. Within this setting, users were provided with all the necessary equipment and tools to complete the task. In real-world scenarios, users might apply different approaches to problem-solving, including other technologies. Future research could attempt to move this experimental environment into the real world and observe how users act and cope with the different methods in innovation challenges.

Second, the task to create an innovative drinking vessel may differ from reality, as such generic challenges may not apply to developing specific innovative products. Moreover, we used a low-tech scenario, which varies from reality. Firms often draw on users to develop new technologies or high-tech products. This predefined task constrains the generalizability of our findings. Researchers could examine the effect of tasks with different complexities and compare the results. Especially for high-technology tasks, it would be interesting to examine the differences between novice and experienced users and digital and physical product modeling.

Third, as part of our experiment, we compared physical and digital product modeling. While we tried to make it as comparable as possible with screenshots and the same presentation, unintended differences between approaches cannot be fully ruled out. Participants or evaluators may prefer the digital approach and regard the physical approach as outdated and unimpressive. Future research could concentrate on one of the two approaches and investigate different toolkits or user groups within the same approach.

Fourth, we developed a novel innovation toolkit using only two software programs. While these programs were carefully selected based on their suitability for the research questions, it is important to acknowledge that there are numerous other software options available. Other software could have offered different foci and possibilities in the development of the innovation toolkit. For instance, software like SolidWorks and AutoCAD provide more focus on 3D modeling and prototyping in the development, whereas Figma and Adobe XD emphasize user interface and experience design. Future research should explore different software options to create a more diverse range of innovation toolkits, propose alternative innovation toolkits, or benchmark different toolkit configurations and options. This would enable a more comprehensive understanding of the potential of various software combinations and provide a basis for the development of innovative new tools.

Finally, users and evaluators may be biased due to cultural differences or personal preferences. Future research could investigate how different cultures or personal preferences influence the new product development process or the evaluation of product ideas.

7. Conclusion

Toolkits for innovation offer various benefits for companies and users by directly providing firms with solution information to users' needs and

enabling users to translate their solution information into a new product. Von Hippel (2001) emphasizes that not only expert users should be able to use toolkits for innovation but also non-expert users. We created a toolkit for innovation and conducted an innovation challenge, showing that non-expert users can leverage the benefits of toolkits for innovation. However, expert users do not create significantly better product ideas when using a toolkit for innovation, demonstrating that toolkits for innovation are a solution for transferring solution information and for closing the design gap between non-expert and expert users.

Acknowledgement

Open Access funding enabled and organized by Projekt DEAL.

Data availability statement

The data that support the findings of this study are available from the corresponding author upon reasonable request.

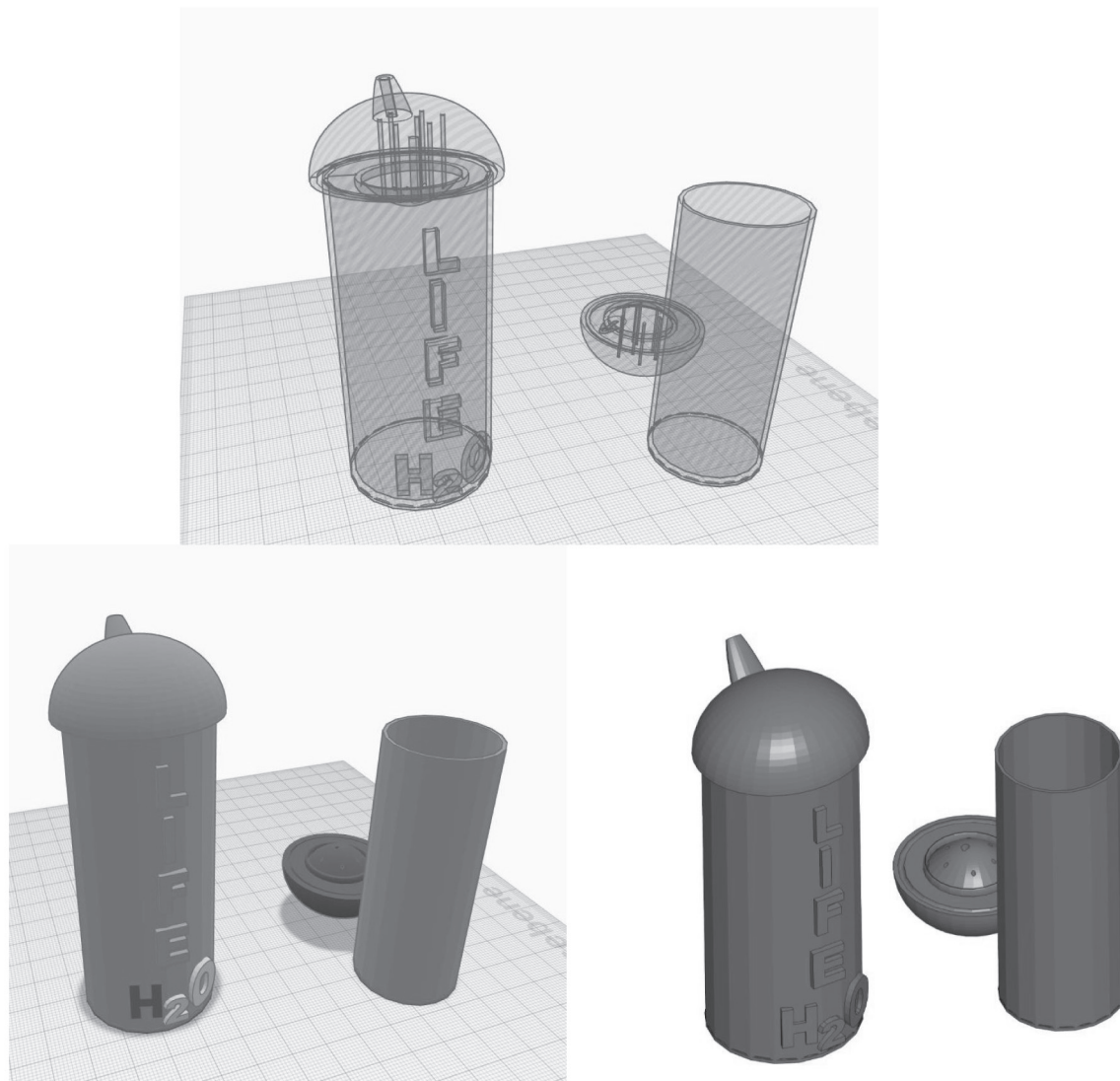
References

- Agarwal, R. and Prasad, J. (1998) A conceptual and operational definition of personal innovativeness in the domain of information technology. *Information Systems Research*, **9**, 2, 204–221.
- Ailawadi, L., Neslin, S., and Gedenk, K. (2001) Pursuing the value-conscious consumer: store brands versus national brand promotions. *Journal of Marketing*, **65**, 71–89.
- Alcácer, J., Cantwell, J., and Piscitello, L. (2016) Internationalization in the information age: a new era for places, firms, and international business networks? *Journal of International Business Studies*, **47**, 2, 499–512.
- Amabile, T.M. (1982) Children's artistic creativity: detrimental effects of competition in a field setting. *Personality and Social Psychology Bulletin*, **8**, 3, 573–578.
- Amabile, T.M. (1996) *Creativity in Context: Update to the Social Psychology of Creativity*. Boulder, CO: Westview Press.
- Appio, F.P., Frattini, F., Messeni Petruzelli, A., and Neirotti, P. (2021) Digital transformation and innovation management: a synthesis of existing research and an agenda for future studies. *Journal of Product Innovation Management*, **38**, 1, 4–20.
- Avey, J.B., Avolio, B.J., Crossley, C.D., and Luthans, F. (2009) Psychological ownership: theoretical extensions, measurement and relation to work outcomes. *Journal of Organizational Behavior*, **30**, 2, 173–191.
- Baldwin, C. and von Hippel, E. (2011) Modeling a paradigm shift: from producer innovation to user and open collaborative innovation. *Organization Science*, **22**, 6, 1399–1417.
- Balka, K., Raasch, C., and Herstatt, C. (2014) The effect of selective openness on value creation in user innovation communities. *Journal of Product Innovation Management*, **31**, 2, 392–407.
- Becker, M., Rullani, F., and Zirpoli, F. (2021) The role of digital artefacts in early stages of distributed innovation processes. *Research Policy*, **50**, 10, 104349.
- Beltagui, A., Rosli, A., and Candi, M. (2020) Exaptation in a digital innovation ecosystem: the disruptive impacts of 3D printing. *Research Policy*, **49**, 1, 103833.
- Boudreau, K., Jeppesen, L., and Miric, M. (2022) Profiting from digital innovation: patents, copyright and performance. *Research Policy*, **51**, 5, 104477.
- Bresciani, S., Huarng, K.-H., Malhotra, A., and Ferraris, A. (2021) Digital transformation as a springboard for product, process and business model innovation. *Journal of Business Research*, **128**, 204–210.
- Bstieler, L., Gruen, T., Akdeniz, B., Brick, D., Du, S., Guo, L., Khanlari, M., McIlroy, J., O'Hern, M., and Yalcinkaya, G. (2018) Emerging research themes in innovation and new product development: insights from the 2017 PDMA-UNH doctoral consortium. *Journal of Product Innovation Management*, **35**, 3, 300–307.
- Chesbrough, H., Lettl, C., and Ritter, T. (2018) Value creation and value capture in open innovation. *Journal of Product Innovation Management*, **35**, 6, 930–938.
- Ciarli, T., Kennedy, M., Massini, S., and Piscitello, L. (2021) Digital technologies, innovation, and skills: emerging trajectories and challenges. *Research Policy*, **50**, 7, 104289.
- Claussen, J. and Halbinger, M. (2021) The role of pre-innovation platform activity for diffusion success: evidence from consumer innovations on a 3D printing platform. *Research Policy*, **50**, 8, 103943.
- Conti, R., Amabile, T.M., and Pollak, S. (1995) The positive impact of creative activity: effects of creative task engagement and motivational focus on college Students' learning. *Personality and Social Psychology Bulletin*, **21**, 10, 1107–1116.
- Crawford, C.M. and Di Benedetto, C.A. (2015) *New Products Management*, 11th edn. New York, NY: McGraw-Hill Education.
- Dawkins, S., Tian, A.W., Newman, A., and Martin, A. (2017) Psychological ownership: a review and research agenda. *Journal of Organizational Behavior*, **38**, 2, 163–183.
- Dellaert, B. and Stremersch, S. (2003) Modelling the consumer decision to mass customize *Proceedings of the 2003 Congress on Mass Customization and Personalization (MCPC 2003)*.
- Di Vaio, A., Palladino, R., Pezzi, A., and Kalisz, D.E. (2021) The role of digital innovation in knowledge management systems: a systematic literature review. *Journal of Business Research*, **123**, 220–231.

- Droge, C., Stanko, M., and Pollitte, A. (2009) Lead users and early adopters on the web: the role of new technology product blogs. *Journal of Product Innovation Management*, **27**, 1, 66–82.
- Elia, G., Margherita, A., and Passiante, G. (2020) Digital entrepreneurship ecosystem: how digital technologies and collective intelligence are reshaping the entrepreneurial process. *Technological Forecasting and Social Change*, **150**, 119791.
- Foucart, R. and Li, Q.C.L. (2021) The role of technology standards in product innovation: theory and evidence from UK manufacturing firms. *Research Policy*, **50**, 2, 104157.
- Franke, N., Keinz, P., and Schreier, M. (2008) Complementing Mass Customization Toolkits with User Communities: How Peer Input Improves Customer Self-Design. *Journal of Product Innovation Management*, **25**, 6, 546–559. <https://doi.org/10.1111/j.1540-5885.2008.00321.x>
- Franke, N. and Piller, F.T. (2004) Value creation by toolkits for user innovation and design: the case of the watch market. *The Journal of Product Innovation Management*, **21**, 6, 401–415.
- Franke, N. and Schreier, M. (2002) Entrepreneurial opportunities with toolkits for user innovation and design. *International Journal on Media Management*, **4**, 4, 225–234.
- Franke, N. and von Hippel, E. (2003) Satisfying heterogeneous user needs via innovation toolkits: the case of apache security software. *Research Policy*, **32**, 7, 1199–1215.
- Friesen, G.B. (2001) Co-creation: when 1 and 1 make 11. *Consulting to Management*, **12**, 1, 28–31.
- Gemser, G. and Perks, H. (2015) Co-creation with customers: an evolving innovation research field. *Journal of Product Innovation Management*, **32**, 5, 660–665.
- Goduscheit, R.C. and Jørgensen, J.H. (2013) User toolkits for innovation – a literature review. *International Journal of Technology Management*, **61**, 3/4, 274.
- Helfat, C.E. (1994) Firm-specificity in corporate applied R&D. *Organization Science*, **5**, 2, 173–184.
- Hendler, S. (2019) Digital-physical product development: a qualitative analysis. *European Journal of Innovation Management*, **22**, 2, 315–334.
- Henkel, J. and Thies, S. (2003) Customization and innovation-user innovation toolkits for simulator software. *Proceedings of the 2003 Congress on Mass Customization and Personalization*.
- Huesig, S. and Endres, H. (2019) Exploring the digital innovation process: the role of functionality for the adoption of innovation management software by innovation managers. *European Journal of Innovation Management*, **22**, 2, 302–314.
- Huffman, C. and Kahn, B.E. (1998) Variety for sale: mass customization or mass confusion? *Journal of Retailing*, **74**, 4, 491–513.
- Ihl, C., Vossen, A., and Piller, F. (2018) All for the money? The limits of monetary rewards in innovation contests with users. *International Journal of Innovation Management*, **23**, 2, 1–27.
- Jeppesen, L.B. (2002) *The Implications of “User Toolkits for Innovation”*. Copenhagen: Copenhagen Business School.
- Jeppesen, L.B. and Molin, M.J. (2003) Consumers as co-developers: learning and innovation outside the firm. *Technology Analysis & Strategic Management*, **15**, 3, 363–383.
- Jong, J.P. de, and E. de Bruijn. (2013) Innovation lessons from 3-D printing. *MIT Sloan Manag. Rev.* **54**, 2, 42–52.
- Kamali, N. and Loker, S. (2002) Mass customization: online consumer involvement in product design. *Journal of Computer-Mediated Communication*, **7**, 4, JCMC741.
- Kristensson, P., Gustafsson, A., and Archer, T. (2004) Harnessing the creative potential among users. *Journal of Product Innovation Management*, **21**, 1, 4–14.
- Kruglanski, A.W. (1975) The endogenous-exogenous partition in attribution theory. *Psychological Review*, **82**, 6, 387–406.
- Lipson, H. and Kurman, M. (2013) *Fabricated: The New World of 3D Printing*. John Wiley & Sons, Hoboken.
- Magee, G.B. (2005) Rethinking invention: cognition and the economics of technological creativity. *Journal of Economic Behavior & Organization*, **57**, 1, 29–48.
- Magnusson, P.R. (2009) Exploring the contributions of involving ordinary users in ideation of technology-based services. *Journal of Product Innovation Management*, **26**, 5, 578–593.
- Marion, T. and Fixson, S. (2021) Exaptation in a digital innovation ecosystem: the disruptive impacts of 3D printing. *Journal of Product Innovation Management*, **38**, 1, 192–215.
- McGraw, K.O. and Wong, S.P. (1996) Forming inferences about some intraclass correlation coefficients. *Psychological Methods*, **1**, 1, 30–46.
- Nambisan, S. (2002) Designing virtual customer environments for new product development. *Academy of Management Review*, **27**, 392–413.
- Nambisan, S. (2017) Digital Entrepreneurship: Toward a Digital Technology Perspective of Entrepreneurship. *Entrepreneurship Theory and Practice*, **41**, 6, 1029–1055. <https://doi.org/10.1111/etap.12254>
- Opland, L.E., Pappas, I.O., Engesmo, J., and Jaccheri, L. (2022) Employee-driven digital innovation: a systematic review and a research agenda. *Journal of Business Research*, **143**, 255–271.
- Pesch, R., Endres, H., and Bouncken, R. (2021) Digital product innovation management: balancing stability and fluidity through formalization. *Journal of Product Innovation Management*, **38**, 6, 726–744.
- Piller, F., Ihl, C., Fuller, J., and Stotko, C. (2004) Toolkits for open innovation: the case of mobile phone games. *Proceedings of the 37th Annual Hawaii International Conference on System Sciences, 2004*, IEEE. p. 10.
- Piller, F.T. and Walcher, D. (2006) Toolkits for idea competitions: a novel method to integrate users in new product development. *R and D Management*, **36**, 3, 307–318.
- Poetz, M.K. and Schreier, M. (2012) The value of crowdsourcing: can users really compete with professionals in generating new product ideas? *Journal of Product Innovation Management*, **29**, 2, 245–256.

- Rindfleisch, A., O'Hern, M., and Sachdev, V. (2017) The digital revolution, 3D printing, and innovation as data. *Journal of Product Innovation Management*, **34**, 5, 681–690.
- Schreier, M. (2006) The value increment of mass-customized products: an empirical assessment. *Journal of Consumer Behaviour*, **5**, 4, 317–327.
- Shrout, P.E. and Fleiss, J.L. (1979) Intraclass correlations: uses in assessing rater reliability. *Psychological Bulletin*, **86**, 2, 420–428.
- Sieger, P., Zellweger, T., and Aquino, K. (2013) Turning agents into psychological principals: aligning interests of non-owners through psychological ownership. *Journal of Management Studies*, **50**, 3, 361–388.
- Teresko, J. (1994) Mass customization or mass confusion. *Industry Week*, **243**, 12, 45–48.
- Toubia, O. and Florès, L. (2007) Adaptive idea screening using consumers. *Marketing Science*, **26**, 3, 342–360.
- Ulrich, K.T. and Eppinger, S.D. (2012) *Product Design and Development*, 5th edn. New York, NY: McGraw-Hill Irwin.
- Urbinati, A., Chiaroni, D., Chiesa, V., and Frattini, F. (2020) The role of digital technologies in open innovation processes: an exploratory multiple case study analysis. *R&D Management*, **50**, 136–160.
- Usai, A., Fiano, F., Messeni Petruzzelli, A., Paoloni, P., Farina Briamonte, M., and Orlando, B. (2021) Unveiling the impact of the adoption of digital technologies on firms' innovation performance. *Journal of Business Research*, **133**, 327–336.
- van Dyne, L. and Pierce, J.L. (2004) Psychological ownership and feelings of possession: three field studies predicting employee attitudes and organizational citizenship behavior. *Journal of Organizational Behavior*, **25**, 4, 439–459.
- von Hippel, E. (2001) User toolkits for innovation. *Journal of Product Innovation Management*, **18**, 4, 247–257.
- von Hippel, E. (2005) Democratizing innovation: the evolving phenomenon of user innovation. *Journal für Betriebswirtschaft*, **55**, 1, 63–78.
- von Hippel, E. (2017) *Free Innovation*. Cambridge, MA: The MIT Press.
- von Hippel, E. and Katz, R. (2002) Shifting innovation to users via toolkits. *Management Science*, **48**, 7, 821–833.
- Wang, G. (2021) Digital reframing: the design thinking of redesigning traditional products into innovative digital products. *Journal of Product Innovation Management*, **39**, 1, 95–118.
- Weisberg, R.W. (1993) *Creativity: Beyond the Myth of Genius*. New York, NY: Freeman.
- Zhu, H., Kock, A., Wentker, M., and Leker, J. (2019) How does online interaction affect idea quality? The effect of feedback in firm-internal idea competitions. *Journal of Product Innovation Management*, **36**, 24–40.
- Thomas Schäper** is Assistant Professor at the Institute for Entrepreneurship at the University of Muenster, Germany. He received his doctoral degree in Innovation Management from University of Muenster, Germany. He earned his Bachelor's and Master's degrees from the University of Muenster, Germany. His research interests lie at the intersection of innovation management, Artificial Intelligence and entrepreneurship. He has published in journals such as *Research Policy* and *R&D Management*.
- Johann Nils Foege** is Professor of Management at the Leibniz University Hannover, Germany. Prior to his appointment in Hannover, he was Assistant Professor of management at the University of Muenster, Germany, where he also completed his habilitation. He received his doctoral degree from RWTH Aachen University, Germany, and has held a position as a visiting scholar at the Centre for Technology Management at the University of Cambridge, United Kingdom, and the Copenhagen Business School, Denmark. His current research interest lies at the intersection of innovation, strategy, and entrepreneurship including such topics as innovation ecosystems, digitization, digital innovation, and sustainability. He has published in journals such as *Research Policy*, *The Journal of Product Innovation Management*, *Long Range Planning* and *R&D Management*.
- Stephan Nüesch** is Professor of Technology and Innovation Management at the University of Fribourg, Switzerland and Director of the International Institute of Management in Technology at the University of Fribourg, Switzerland. He is also affiliated to the University of Muenster, where he was Professor and Head of the Business Management at the University of Muenster. He holds a PhD in Business Management from the University of Zurich, Switzerland. His current research interest lies at the intersection of innovation management and strategic management. His work has been published in international journals such as *Research Policy*, *Journal of Economic Behavior & Organization*, *Long Range Planning* and *R&D Management*.

APPENDIX A

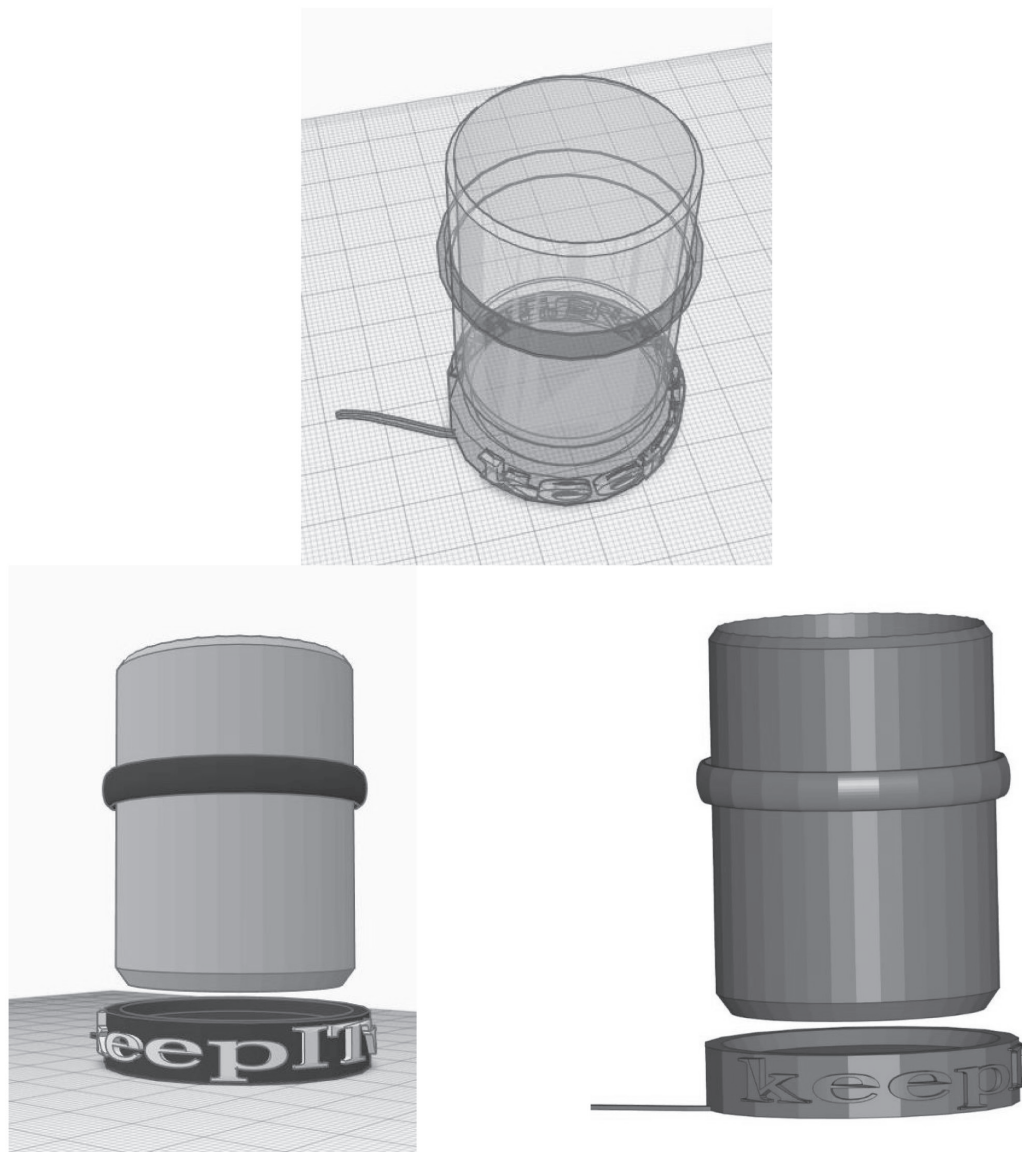
Life H₂O

Life H₂O combines an ordinary drinking bottle with the so-called Life Straw. The cap can be unscrewed and a customized version of the Life Straw can be found on its bottom side. It filters 99.9% of all bacteria and impurities from water. This is especially beneficial for third-world countries as contaminated water can be drunk without health concerns. One life straw is sufficient for the consumption of several thousand liters of water and can be easily exchanged.

Most Innovative Idea, Toolkit for Innovation Modeling, Non-Expert User, Innovativeness Score: 5.30

Figure A1. Examples of product ideas created with a toolkit for innovation or physical product modeling. [Colour figure can be viewed at [wileyonlinelibrary.com](https://onlinelibrary.wiley.com)]

KeepItWarm

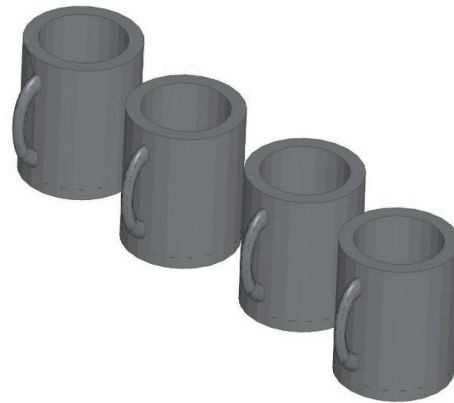
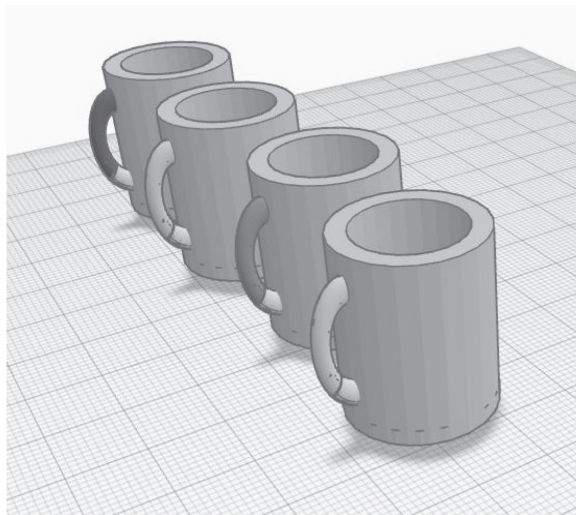
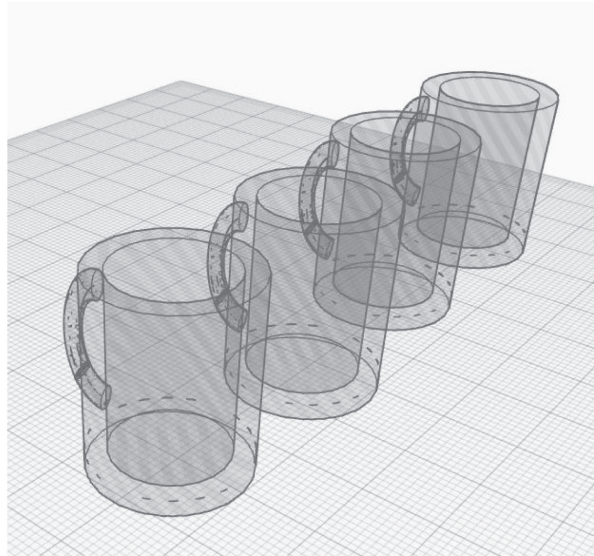


The mug is made of aluminum, the ring made of silicone (available in different colors), and the base made of plastic with an induction coil and a USB port. Due to the USB-powered heating coil, the coffee, tea, or hot chocolate always stays warm.

Second Most Innovative Idea, Toolkit for Innovation Modeling, Non-Expert User, Innovativeness Score: 5.17

Figure A1. (Continued)

The Hot Experience

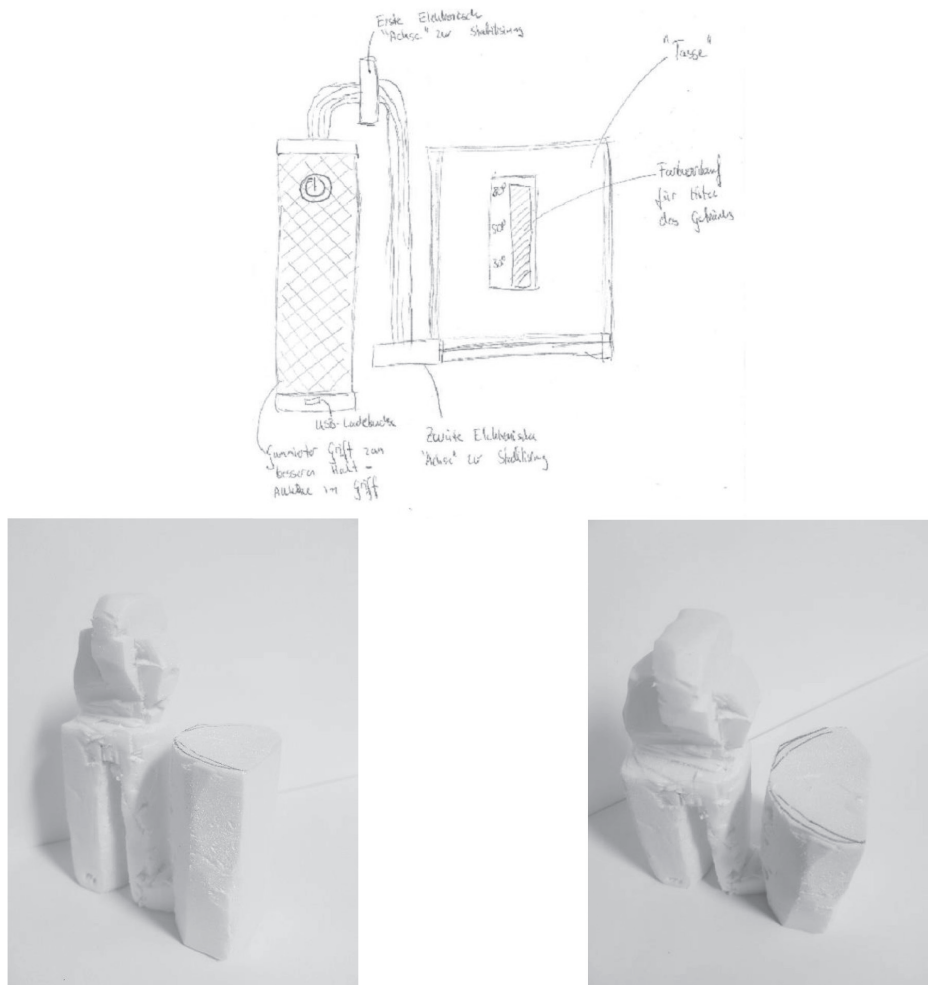


You usually drink tea or coffee while you are working or relaxing. If the drinks are freshly prepared, you might burn your tongue. If the coffee or tea is still too hot, the handle turns red. If it is the right temperature to drink, the handle turns green (color gradient: red (too hot) - green (warm) - blue (cold)). You can perfectly enjoy your drink with “the hot experience” without burning your tongue.

Third Most Innovative Idea, Toolkit for Innovation Modeling, Expert User, Innovativeness Score: 4.96

Figure A1. (Continued)

StableCup

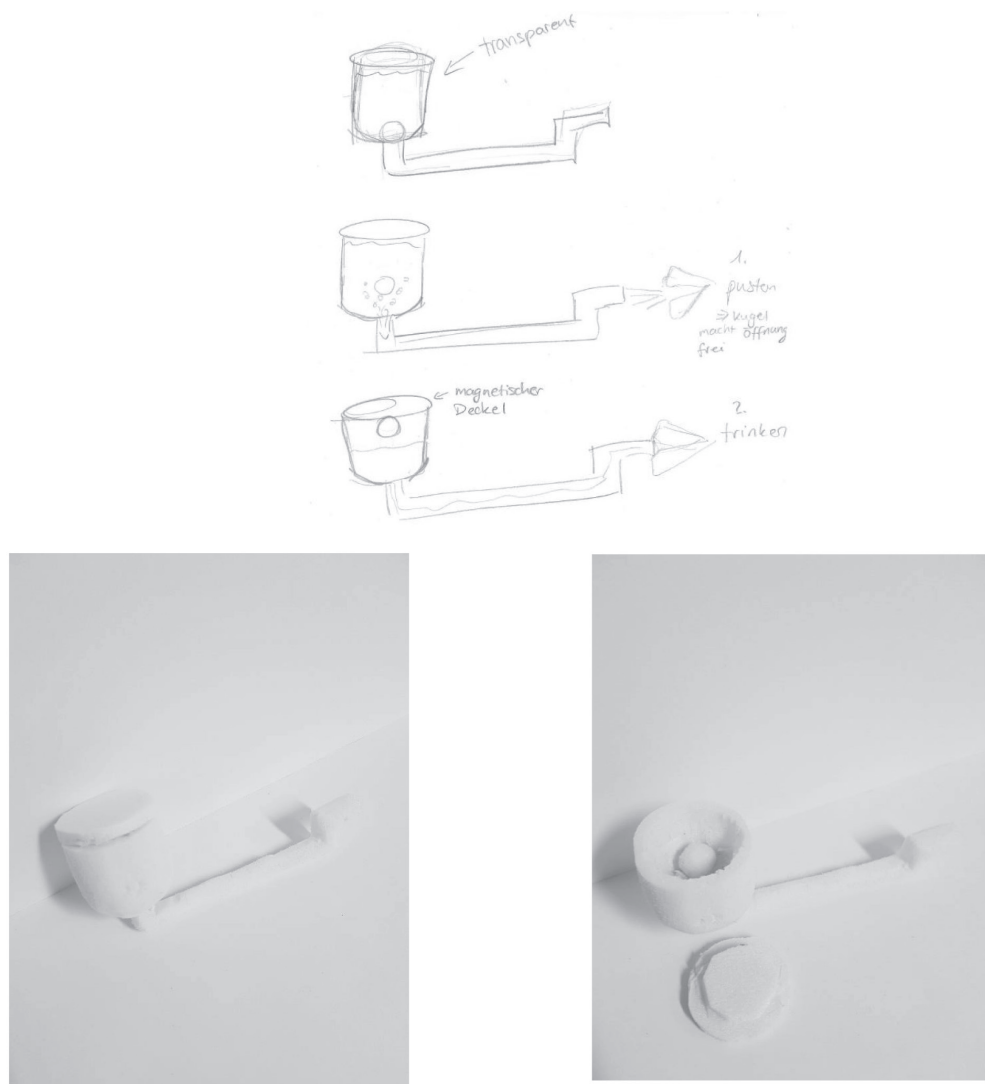


The cup is primarily designed for Parkinson's patients as they have problems with holding vessels without spilling.
Idea: Adapt stabilizer technology from camera systems or gimbals to stabilize the vessel so that the shaking of the hands can be compensated.
Functions: Stabilization of the drinking vessel, heat indicator for liquids with color gradient, water resistance, chargeable via USB port, on/off button on the handle

Most Innovative Idea, Physical Product Modeling, Non-Expert User, Innovativeness Score: 5.91

Figure A1. (Continued)

Drink Fun

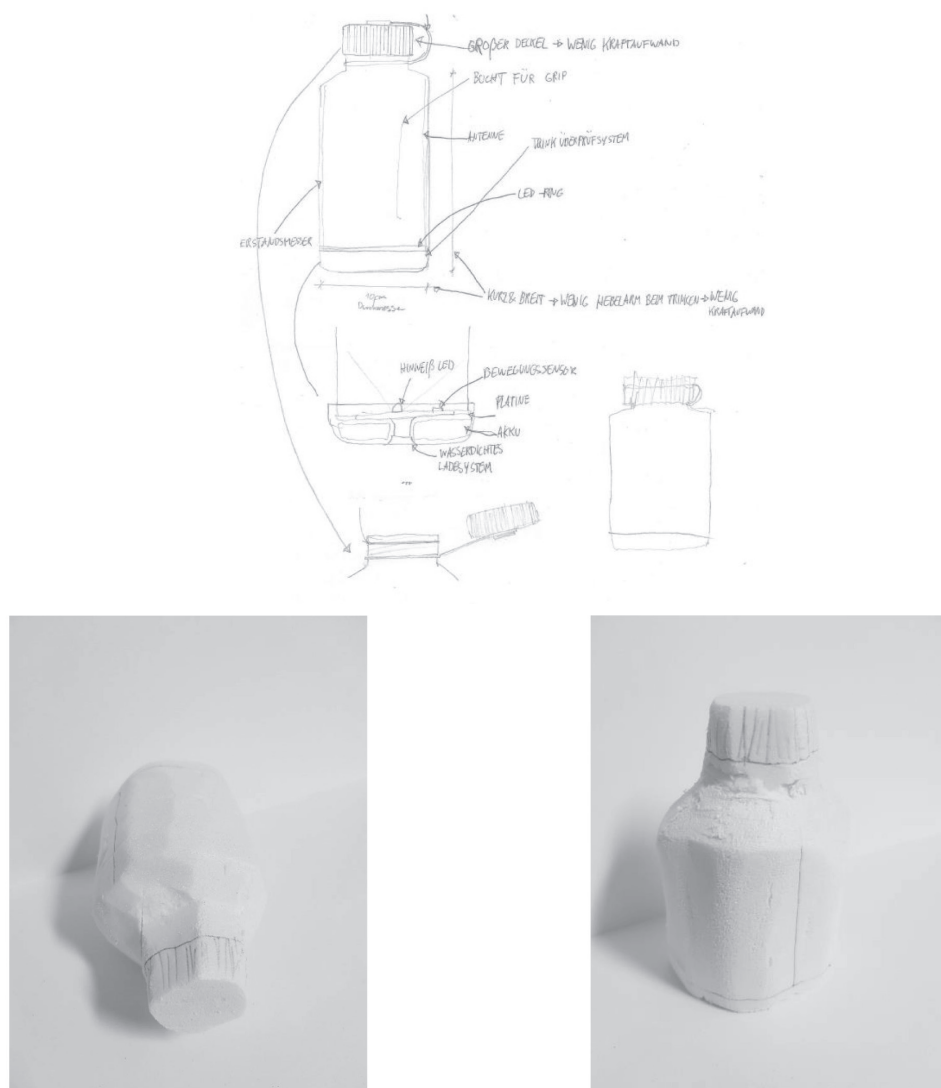


The aim of the product is to make it easier for parents to give medicine to their children. This is especially interesting for children who have a serious illness and therefore need to take medicine daily. To fill the vessel, remove the cap and make sure that the ball lies on the sealing ring at the bottom. First, the child puts the transparent straw in the mouth and sees the ball in the liquid. Second, the child must blow through the straw until the ball touches the cap and gets stuck due to a magnetic plate. Children are interested in this game because it is usually forbidden to make bubbles in their drinks. Finally, the liquid can be drunk by sucking on the straw. It should combine the unpleasant drinking of medicine with fun.

Second Most Innovative Idea, Physical Product Modeling, Expert User, Innovativeness Score: 5.71

Figure A1. (Continued)

 Drinking Reminder



The daily fluid intake is a major problem for older people, especially for patients with Alzheimer's. The nursing staff is not able to check the fluid intake constantly. The Drinking Reminder measures the amount of water which is left in the bottle and reminds to drink at regular intervals. This is done with a LED light, which attracts attention by slowly flashing. The Drinking Reminder is connected via Wi-Fi to the care center, which is warned if not enough water is consumed. The bottle can also be filled with other liquids such as soup or food replacement products that support food intake. The battery can be easily charged. The bottles can be washed in the dishwasher and have an automatic night mode.

Third Most Innovative Idea, Physical Product Modeling, Expert User, Innovativeness Score: 5.58

Figure A1. (Continued)